

You'll find a complete list of the test equipment for calibrating your Tektronix instrument in the instruction manual received with that instrument. Some of the items listed are Tektronix Calibration Fixture—items which we have designed and made available for the sole purpose of assisting you to service your Tektronix instruments accurately and efficiently. This booklet describes those Calibration Fixtures which are not found in the Tektronix Instrument Catalog. For prices refer to the Parts Price List, available to you through your Tektronix Field Office, Field Representative or Distributor; if you need more information they will be pleased to help you.

Information in this publication supersedes all previously published material. Specification change privileges reserved.

ALIGNMENT TOOLS

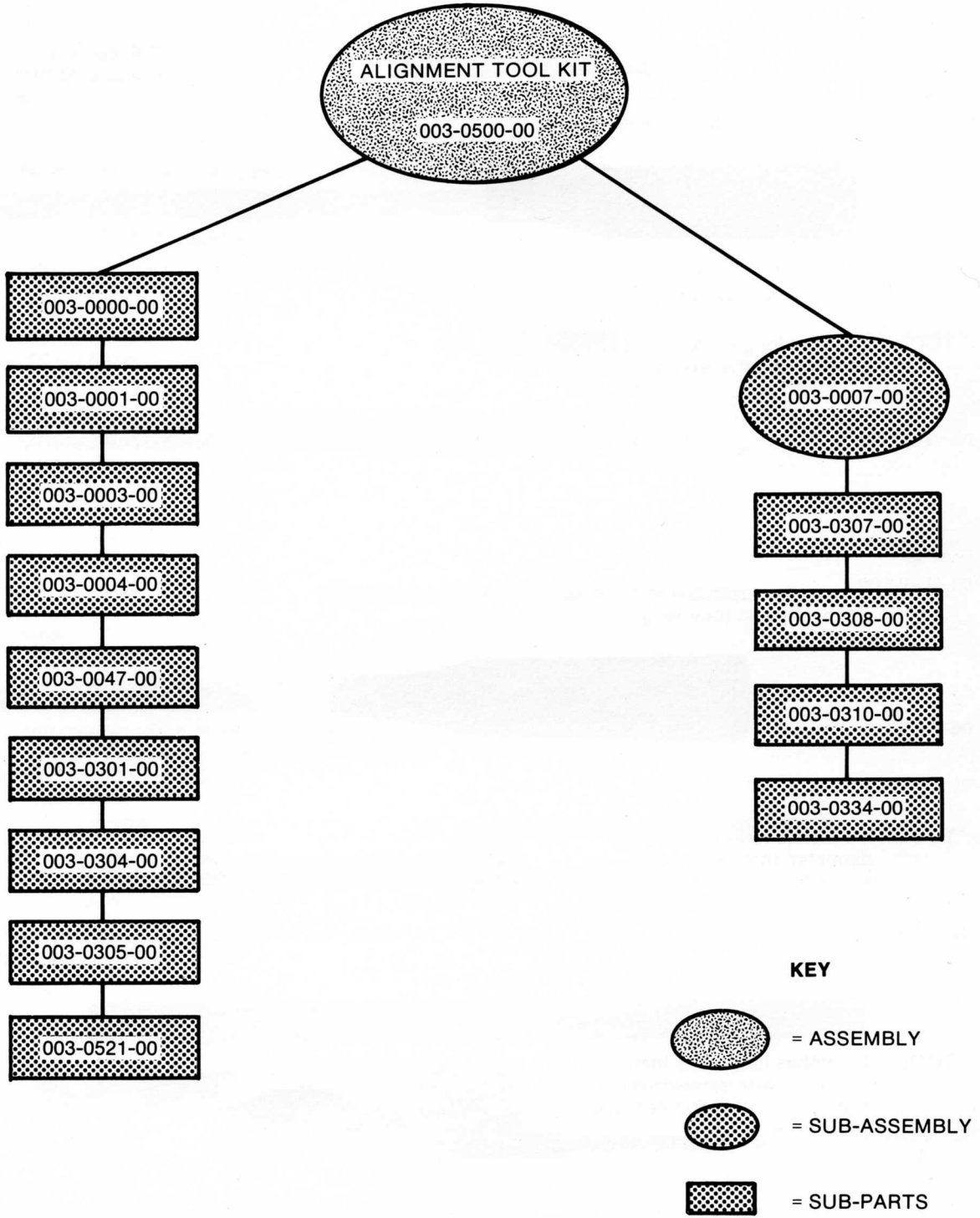

SEE FOLLOWING PAGES FOR PICTURES AND DESCRIPTIONS.

ALIGNMENT TOOLS

TOOL: 1½ inch shaft; 5 inches total length, plastic shaft and handle, metal screwdriver tip.



003-0000-00

TOOL: 7 inch shaft; 10½ inches total length, plastic shaft and handle, metal screwdriver tip.



003-0001-00

TOOL: 6 inches long by ⅜ inch diameter, nylon, with screwdriver shaped ends.



003-0008-00

TOOL: 3 inch plastic shaft and handles, metal screwdriver tip, 6½ inches total length.



003-0047-00

TOOL: 4¾ inches long by ¼ inch diameter shaft with metal screwdriver tip and knob for handle, for tuning 517 vertical trimmers.



003-0374-00

TOOL: 4¼ inches long by ⅝ inch diameter, with screwdriver handle, for ERIE 557 ceramic capacitors.



003-0521-00

ALIGNMENT TOOLS

HANDLE: Uses 003-0304-00 insert.

003-0305-00



HANDLE: Nylon, uses 003-0008-00, 003-0010-00 and 003-0334-00 inserts.

003-0307-00



INSERT: Low capacity nylon with wire pin, 7/8 inches long when inserted into handles for 551 right hand delay line. Requires 003-0305-00 handle.

003-0304-00



INSERT: For turret attenuators, requires 003-0307-00 handle.

003-0308-00



INSERT: 0.077 inch outside diameter, use with 003-0307-00 handle, for 5/64 inch inside diameter hex cores.

003-0310-00



INSERT: Nylon, use with 003-0307-00 handle, for turret attenuator.

003-0334-00

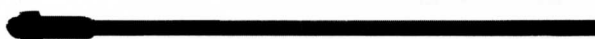

ROD: 7 inches long, plastic rod with recessed metal screw-driver tips, one end for #4 studs and the other end for #6 studs. Walsco #2519 or equal.

003-0003-00



ROD: 7 1/2 inches long, plastic rod with 1/4 inch hex socket at each end. Walsco #2503 or equal.

003-0004-00



ROD: 5 inches long, plastic, for 0.100 inch inside diameter powdered iron hex slugs.

003-0301-00



Items on this page are no longer available.

ITEM NUMBER	ITEM NAME	ITEM NUMBER	ITEM NAME
067-0042-00	BRIDGE, RES	067-0126-00	FILM, PHOTO, PRCS
067-0043-00	CHECKER, CAP	067-0127-00	FILM, PHOTO, PRCS
067-0044-00	VOLTMETER	067-0128-00	FILM, PHOTO, PRCS
067-0046-00	MULTIMETER	067-0129-00	FILM, PHOTO, PRCS
067-0047-00	METER	067-0130-00	FILM, PHOTO, PRCS
067-0048-00	CONTROL, LINE V	067-0131-00	FILM, PHOTO, PRCS
067-0049-00	LOAD, BALLAST	067-0132-00	FILM, PHOTO, PRCS
067-0051-00	CONTROL, LINE V	067-0133-00	FILM, PHOTO, PRCS
067-0052-00	XFMR, PWR, STU	067-0134-00	FILM, PHOTO, PRCS
067-0053-00	CYCLER, PLUG-IN	067-0135-00	FILM, PHOTO, PRCS
067-0054-00	UNIT, CYCLING	067-0136-00	FILM, PHOTO, PRCS
067-0060-00	TEST, SET, ELECTRN	067-0137-00	FILM, PHOTO, PRCS
067-0061-00	JIG, VERT AMPL	067-0138-00	FILM, PHOTO, PRCS
067-0062-00	CHECKER, RES	067-0139-00	FILM, PHOTO, PRCS
067-0063-00	KIT TOOL	067-0140-00	FILM, PHOTO, PRCS
067-0065-00	UNIT, TEST LOAD	067-0141-00	FILM, SCOPE
067-0066-00	UNIT, TEST	067-0142-00	FILM, PHOTO, PRCS
067-0068-00	LOAD, DUMMY	067-0143-00	FILM, PHOTO, PRCS
067-0069-00	LOAD, CYCLING	067-0501-00	FIXTURE, CAL
067-0070-00	LOAD, CYCLING	067-0505-00	FIXTURE, CAL
067-0071-00	CABLE ASSY, RF	067-0514-00	FIXTURE, CAL
067-0072-00	CABLE ASSY, RF	067-0516-00	FIXTURE, CAL
067-0073-00	CABLE ASSY, RF	067-0519-00	FIXTURE, CAL
067-0076-00	PICKER, OHM	067-0524-00	FIXTURE, CAL
067-0078-00	ADAPTER, CAL	067-0526-00	FIXTURE, CAL
067-0081-00	MIXER, RECTIFIER	067-0534-00	FIXTURE, CAL
067-0083-00	COUPLER, AC	067-0545-00	FIXTURE, CAL
067-0085-00	UNIT, CYCLE DLY	067-0546-00	FIXTURE, CAL
067-0086-00	PANEL, V ACCESS	067-0565-00	FIXTURE, CAL
067-0087-00	JIG, NUVISTOR TE	067-0570-00	FIXTURE, CAL
067-0088-00	SOURCE, DC	067-0570-01	FIXTURE, CAL
067-0089-00	CONNECTOR, INPUT	067-0604-00	FIXTURE, CAL
067-0091-00	SHIELD, TUNING	067-0623-00	FIXTURE, CAL
067-0092-00	SHIELD, TUNING	067-0627-00	FIXTURE, CAL
067-0093-00	SHIELD, TUNING	067-0628-00	FIXTURE, CAL
067-0094-00	SHIELD PAIR	067-0629-00	FIXTURE, CAL
067-0099-00	POWER SUPPLY	067-0631-00	FIXTURE, CAL
067-0102-00	GEN, TIME MARK	067-0638-00	FIXTURE, CAL
067-0103-00	GEN, WAVEFORM	067-0642-00	FIXTURE, CAL
067-0104-00	HOLDER POCKET	067-0660-00	FIXTURE, CAL
067-0108-00	BRIEF CASE	067-0679-00	FIXTURE, CAL
067-0112-00	BRIDGE 50	067-0717-00	FIXTURE, CAL
067-0113-00	JIG, XFMR TEST	067-0722-00	FIXTURE, CAL
067-0117-00	PRISM, TUNING	067-0752-00	FIXTURE, CAL
067-0121-00	LUBRICANT	067-0770-00	FIXTURE, CAL
067-0124-00	FILM, CRT WINDOW	067-0771-00	FIXTURE, CAL
067-0125-00	FILM, PHOTO, PRCS	067-0780-00	FIXTURE, CAL

Please order items on this page by replacement part number.

ITEM NUMBER	ITEM NAME	REPLACED BY	ITEM NUMBER	ITEM NAME	REPLACED BY
067-0045-00	MULTIMETER	006-0191-00	067-0561-00	FIXTURE, CAL	067-0561-01
067-0067-00	DUMMY LOAD, ELEC	067-0528-00	067-0572-00	FIXTURE, CAL	067-0572-01
067-0074-00	CAL, AMPLITUDE	067-0508-00	067-0576-00	FIXTURE, CAL	015-0149-00
067-0075-00	ATTENUATOR, FXD	067-0529-00 067-0530-00 067-0531-00 Depending on inst.	067-0583-00	FIXTURE, CAL	1410C
067-0077-00	FIXTURE, CAL	067-0502-01	067-0587-00	FIXTURE, CAL	067-0587-02
067-0079-00	CHECKER	067-0507-00	067-0587-01	FIXTURE, CAL	067-0587-02
067-0080-00	DIVIDER, CAL	067-0529-00 and 067-0531-00	067-0636-00	FIXTURE, CAL	067-0652-00
067-0082-00	ATTENUATOR, VAR	067-0511-00	067-0645-00	FIXTURE, CAL	067-0645-03
067-0084-00	STANDARD CAP	067-0500-00	067-0645-01	FIXTURE, CAL	067-0645-02
067-0090-00	CONNECTOR, INPUT	BNC connectors use (3) 067-0525-01 UHF connectors use (3) 067-0525-01 + (4) 103-0015-00	067-0650-00	FIXTURE, CAL	SG504
067-0097-00	PEN, MARKING	002-0919-00	067-0651-00	FIXTURE, CAL	067-0652-00
067-0098-00	CLEANER, PEN	002-0920-00	067-0669-00	FIXTURE, CAL	067-0669-01
067-0100-00	CASE, CARRYING	437-0070-00	067-0681-00	FIXTURE, CAL	067-0681-01
067-0101-00	FIXTURE, CAL	006-0195-00	067-0693-00	FIXTURE, CAL	067-0693-01
067-0105-00	CASE, DISPATCH	002-1172-00	067-0694-00	FIXTURE, CAL	067-0594-00
067-0106-00	CASE, RING BDR	002-0605-00	067-0696-01	FIXTURE, CAL	067-0696-01
067-0107-00	BRIEF CASE	002-0603-00	067-0704-00	FIXTURE, CAL	067-0704-01
067-0109-00	CASE, UNDERARM	002-0600-00	067-0769-00	FIXTURE, CAL	067-0788-00
067-0110-00	FIXTURE, CAL	067-0554-00	067-0769-01	FIXTURE, CAL	067-0788-00
067-0111-00	ATTENUATOR, VAR	067-0511-00	067-0778-01	FIXTURE, CAL	067-0788-00
067-0114-00	CONNECTOR, INPUT	BNC connectors use (3) 067-0525-01 UHF connectors use (3) 067-0525-01 + (4) 103-0015-00	067-0781-00	FIXTURE, CAL	067-0781-01
067-0115-00	SOCKET, CPLG	003-0382-00	067-0823-00	FIXTURE, CAL	067-0823-01
067-0116-00	PLIERS, ELEK	003-0383-00	067-0836-00	FIXTURE, CAL	067-0836-01
067-0118-00	ADAPTOR, INPUT	067-0531-00	067-0848-00	FIXTURE, CAL	015-0358-00
067-0119-00	WRENCH, SPANNER	003-0373-00	067-0860-00	FIXTURE, CAL	067-0860-01
067-0120-00	ATTENUATOR, FXD	067-0515-00	067-0871-00	FIXTURE, CAL	006-2487-00
067-0122-00	LUBRICANT	006-0219-00			
067-0123-00	LUBRICANT	006-2574-00			
067-0502-00	FIXTURE, CAL	067-0502-01			
067-0506-00	FIXTURE, CAL	SG503			
067-0513-00	FIXTURE, CAL	S52			
067-0520-00	FIXTURE, CAL	067-0521-01			
067-0521-00	FIXTURE, CAL	067-0521-01			
067-0522-00	FIXTURE, CAL	067-0544-00			
067-0525-00	FIXTURE, CAL	067-0525-01			
067-0532-00	FIXTURE, CAL	SG503 or SG504			
067-0532-01	FIXTURE, CAL	SG503 or SG504			
067-0548-00	FIXTURE, CAL	234			

CALIBRATION FIXTURES

067-0500-00

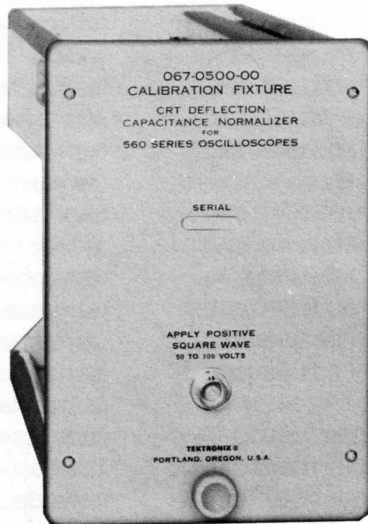

Plug-in unit for normalizing CRT deflection plate capacitance in 560 series instruments.

067-0502-01

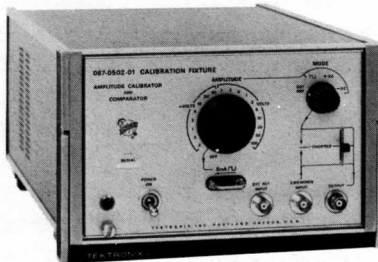

Amplitude Calibrator and Comparator. Provides an accurate source for positive and negative DC voltage and current as well as 60 Hz and 1 kHz squarewaves.

The Amplitude Calibrator and Comparator is intended to be used for verifying the accuracy of Tektronix oscilloscope amplitude calibrators.

067-0503-00



Precision DC Divider. Used to test the attenuation ratio of the input attenuators in such plug-ins as the W Unit, 10A1 and 3A7.

067-0507-00

Grid Current Checker. Used to measure grid current in the Type O and other operational amplifiers.

067-0508-00

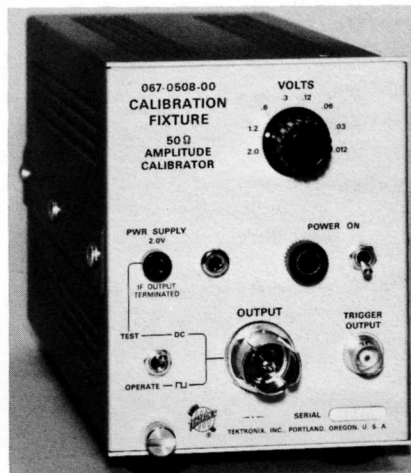

This calibrator provides a source of voltage, the overall accuracy of which is $\pm 0.25\%$, from an accurate 50 ohm source resistance to calibrate equipment having a characteristic 50 ohm impedance. It may also calibrate a high impedance input provided the unit is accurately terminated in total load of 50 ohms.

067-0510-00

Signal Pickoff Extension. Used to measure risetime and aberrations of the 10A2A.

067-0511-00

Variable Attenuator which has the end terminals of a 100 ohm potentiometer connected from input to ground and the potentiometer divider arm connected to the attenuator output. The attenuator is not matched to any particular impedance system. Unit will attenuate a 1 ns risetime pulse in a 50 ohm system with negligible distortion.

067-0515-00

A 0.1% 50 ohm Termination. Used with instruments that have outputs into 50 ohms. This calibration fixture is used to accurately terminate an instrument into 50 ohms to check its calibration accuracy. Its primary intent is for use with the 067-0508-00, the 50 ohm Amplitude Calibrator, but can also be used for checking the calibrator outputs into 50 ohms, of the Type 546, 547, 567, etc.

067-0517-00

Modification Kit for the Type 111 Pretrigger Pulse Generator that will give a signal output for every other pretrigger output. This type of signal/trigger combination is useful for checking calibration and performance of sampling systems.

FOR TEKTRONIX PRODUCTS

067-0518-00



Calibration Fixture. Permits simultaneous modulation of an RF signal with Tektronix Type 106 Squarewave Generator and with an audio generator.

067-0523-00



Calibration Fixture. Used with Tektronix 580-Series oscilloscopes. The calibration fixture provides a reference signal for setting the oscilloscope vertical amplifier gain, a fast-rise voltage step for adjusting oscilloscope vertical amplifier transient response, and a load bank which loads the oscilloscope power supplies over their full current range. The 067-0523-00 allows a check of the DC balance of the oscilloscope vertical amplifier.

067-0528-00



Calibration Fixture. Provides LO-Load equivalent to one Type 122 Amplifier Unit and HI-Load equivalent to four Type 122 Amplifier Units, to check 125 Power Supply.

067-0521-01



Calibration Fixture. A versatile single-unit calibration aid for use with all Tektronix 530-, 540-, or 550-Series Oscilloscopes using 1-series or letter-series vertical plug-in units.

The Type TU-7 Type 1M1, 067-0521-00 and 067-0521-01 are electrically similar instruments. The Type designation was changed from TU-7 to Type 1M1 at Serial Number 500, to 067-0521-00 at Serial Number 1387, and to 067-0521-01 at Serial Number 3995.

067-0525-01

Dual BNC Connector. Designed for inserting identical signals into both channels of a dual-channel plug-in unit simultaneously. Common Mode Rejection (CMR) can be conveniently checked with no significant effect from the Dual BNC Connector. The two lengths of RG 58 are matched to less than 0.1".

067-0529-00

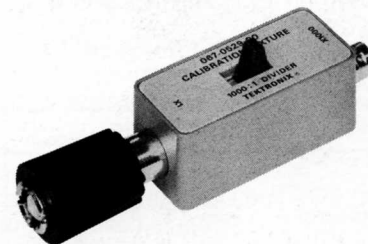

A 1000:1 Divider. Used with Standard Amplitude Calibrator (067-0502-01) to extend range of output voltage to amounts less than 200 microvolts.

CALIBRATION FIXTURES

067-0530-00

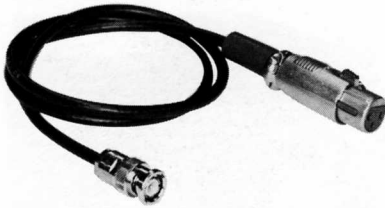

Adapter Cable. Used between BNC source of calibrator signal and input to three-pin Cannon connector, such as used on Type E Plug-in and Type 122 Amplifier.

067-0531-00

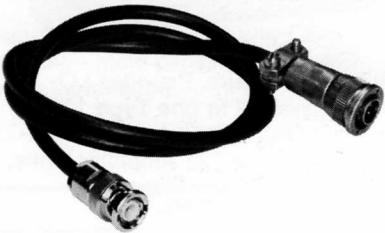

Adaptor Cable. Used between BNC source of calibrator signal and input to four-pin Cannon connector, such as used on Type 2A61 Plug-in Unit.

067-0533-00

Input RC Time Constant Normalizer. Used with signal inputs having nominal 1 megohm \times 20 pF input RC time constant and having UHF connectors.

067-0535-00

Input RC time Constant Normalizer. Used with signal inputs having nominal 1 megohm \times 47 pF input RC time constant and having UHF connectors.

067-0536-00

Input RC Time Constant Normalizer. Used with signal inputs having nominal 1 megohm \times 12 pF input RC time constant and having BNC connectors.

067-0537-00

Input RC Time Constant Normalizer. Used with signal inputs having a nominal 1 megohm \times 15 pF input RC time constant and having BNC connectors.

067-0538-00

Input RC Time Constant Normalizer. Used with signal inputs having a nominal 1 megohm \times 20 pF input RC time constant and having BNC connectors.

067-0539-00

Input RC Time Constant Normalizer. Used with signal inputs having a nominal 1 megohm \times 24 pF input RC time constant and having BNC connectors.

067-0540-00

33 pF Input Normalizer. Used for checking or adjusting the input capacitance of oscilloscopes, or oscilloscope plug-in units, where high impedance attenuator probes may be used.

067-0541-00

Oscilloscope 47 pF input normalizer with BNC connectors.

067-0544-00



Test Unit. A calibration aid for the Type 647A or Type RM647A Oscilloscope. The unit is designed to calibrate and standardize both the vertical and horizontal circuitry of the Type 647A.

067-0549-00



When used in conjunction with standard electronic signal generators, the Input Adapter for the Type 410 makes it easily possible to apply all input signals required to check the electrical performance of the Type 410 Physiological Monitor.

067-0552-00

Input RC Time Constant Normalizer. Used with signal inputs having nominal 1 megohm \times 30 pF input RC time constant and having BNC connectors.

FOR TEKTRONIX PRODUCTS

067-0553-00

Insertion Unit. Used with the Type 454 Oscilloscope. This enables the Calibrator to insert a fast ns signal between the preamplifier and the delay line, making possible the adjustment of the main amplifier before the pream is adjusted.

067-0553-01

Signal Insertion Unit. Used with the 454A Oscilloscope. The Insertion Unit enables the oscilloscope calibrator to insert a fast signal between the preamplifier and the delay line to allow the main amplifier to be adjusted before the preamplifier.

067-0554-00

Tunnel Diode Pulser. Provides a fast-rise pulse for adjusting the transient response of high-frequency units such as the Tektronix Types 82, 86, 10A2A and 453.

067-0559-00



Current Probe Test Fixture. A 50 ohm termination and current source for calibration of current Probes. This device is connected to a 50 ohm generator (109, 106) to terminate it in 50 ohms.

067-0561-01



Test Display Generator. A ramp/staircase generator used for testing storage monitors such as the Tektronix Type 601, 611, and 613.

067-0562-00

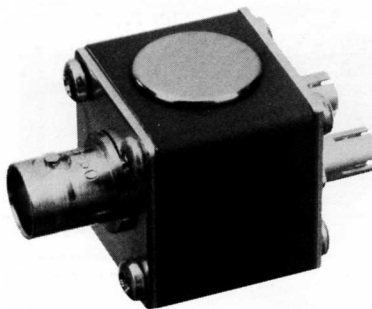

P6046 Input Adapter. A device which connects the P6046 dual input tips together to the center conductor of a BNC connector.

067-0563-00

P6046 Calibration Shield. A P6046 cover with perforations to reach the calibration adjustments. The cover aids in simulating the total enclosure of the original cover while setting the high frequency adjustments.

067-0569-00



An adjustable attenuator capable of attenuating a sweep sawtooth waveform to one volt amplitude. Usable in calibration of storage monitors, such as Types 601, 611 and display monitor Type 602.

067-0571-00

Calibration Shield. Used with Type 323 Oscilloscope. An aluminum cover which simulates the shielding of the instrument case while performing the vertical and horizontal calibration adjustments.

067-0572-01



Normalizer Head. Designed for use with all Tektronix vertical sampling plug-in units that utilize sampling heads.

CALIBRATION FIXTURES

067-0573-00

Calibration Graticule. Used with the Type 611 Storage Monitor (S/N B202949 and below). Its lines and grids define the perimeter of the quality area, the display center, and assist in calibrating the yoke alignment, gain, linearity and settling time.

067-0573-01

Same as 067-0573-00 except this is for 611 S/N B202950 and up.

Used in calibration procedure to set up:

- Trace Alignment
- Yoke Alignment
- Horizontal Gain
- Vertical Gain
- Vertical and Horizontal Line Straightness
- Linearity
- Settling Time

067-0575-00



High Pass Filter. Used to check the third harmonic distortion of the 015-0107-00 Swept Frequency Converter.

067-0587-02

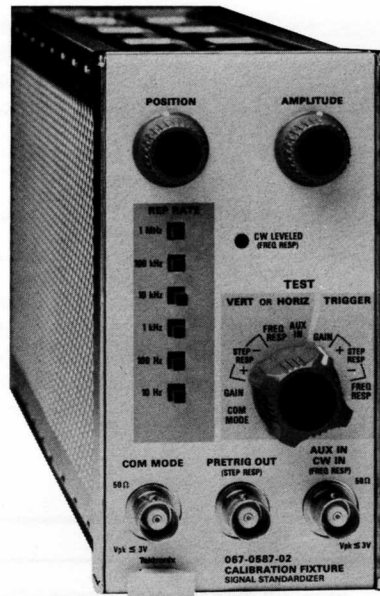

Mainframe Standardizer. Used on 7000 Series vertical and horizontal calibration.

067-0589-00

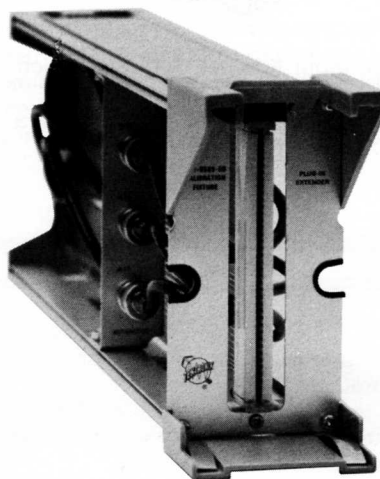

Extender. Used for calibrating or trouble-shooting 7-Series Plug-in Units operating in a 7000-Series Oscilloscope. The Extender allows the plug-in unit to be operated out of the oscilloscope plug-in compartment, thus providing easy access to components and adjustments.

067-0590-00

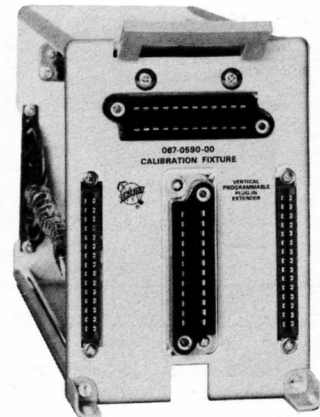

Plug-In Extender. Designed primarily for use with the Tektronix Type 568 or R568 Oscilloscope when calibrating or troubleshooting the Type 3S5 or 3S6 Programmable Vertical. The Extender can also be used with the Type 568 or other 560-Series Oscilloscopes to extend digital vertical plug-in units, as well as non-digital vertical and time-base units.

067-0591-00

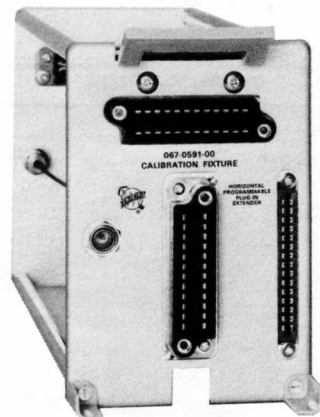

Plug-In Extender. Designed primarily for use with the Tektronix Type 568 or R568 Oscilloscope when calibrating or troubleshooting the Type 3T5 or 3T6 programmable Time Base. The Extender can also be used with the Type 568/R568 or other 560-Series Oscilloscopes to extend digital time-base units, as well as non-digital time base and vertical units. When used with 560-Series Oscilloscopes other than the Type 568/R568, the connector P-23 must be removed from the rear panel of the unit. A holder is provided for storing the connector when not in use.

FOR TEKTRONIX PRODUCTS

067-0594-00

Harmonic Generator. Designed for use (along with Type 067-0595-00 200 MHz Notch Filter) with Tektronix microwave spectrum analyzers.

067-0595-00

200 MHz Notch Filter. Designed for use with Type 067-0594-00 Harmonic Generator. These calibration fixtures, together with a time-mark generator, provide frequency markers suitable for calibrating microwave spectrum analyzers.

067-0596-00



Chopped Voltage Reference. Provides two precise voltages for differential amplitude measurements. This calibration fixture is specifically designed for use with the Tektronix Type 1A5 Differential Amplifier in measuring television waveform amplitudes.

067-0599-00

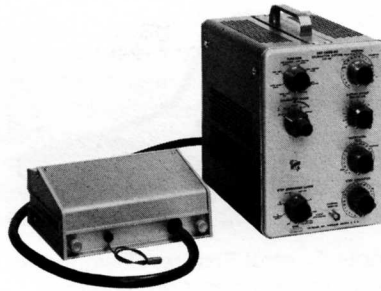

Calibration Fixture. Designed specifically for calibrating and testing the performance of the 576 Curve Tracer.

067-0601-00



Television Test Signal Generator. A small, portable source of composite, interlaced television signals for almost any TV system. A plug-in unit provides the control of the line and field rate, sync timing, and sync pulse counter. The signal generator is intended for calibration and adjustment of television waveform monitors and other equipment requiring a composite video waveform for functional checkout.

067-0603-00

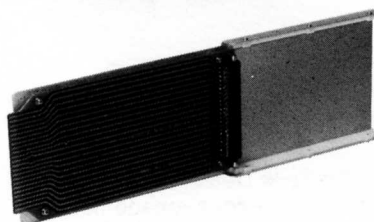

Readout Extender. Designed for use with the Tektronix Type 576 Curve Tracer. The Extender provides facility for servicing the readout circuits.

067-0608-00

Calibration Fixture. Designed to provide overdrive signals for measuring the overdrive recovery time of Tektronix plug-in amplifiers.

067-0609-00

Common Mode Rejection Checker. Used in conjunction with the 067-0587-00 Signal Standardizer Fixture to determine the CMRR of 7000-Series Mainframe Vertical Interface Amplifiers. The 067-0609-00 CMR Checker plugs into both mainframe Vertical connectors at the same time. It accepts the 067-0587-00 Signal Standardizer through the left Vertical compartment of the mainframe. The 067-0609-00 routes the CW signal from the 067-0587-00 to both mainframe Vertical inputs, maintaining 50 ohm terminations to the Signal Standardizer. Precision-length coaxial cables introduce time delay to equalize arrival time of waveforms to each Vertical connector.

067-0611-00

Circuit Board Extender for 56 pin circuit board connectors. The extender allows the board being serviced to be inverted from its normal position, providing another degree of freedom servicing circuit boards. Its initial use is for the Tektronix Type 4501 Scan Converter. Test points provide easy access to each of the 56 connections.

067-0612-00

Circuit Board Extender for 56 pin circuit board connectors. Its initial use is to provide facility for servicing circuit boards in the Tektronix Type 4501 Scan Converter. Test points provide easy access to each of the 56 connections.

CALIBRATION FIXTURES

067-0613-00

Circuit Board Extender for 30 pin circuit board connectors. Its initial use is to provide facility for servicing circuit boards in the Tektronix Type 4501 Scan Converter. Test points provide easy access to each of the 30 connections.

067-0615-00

Circuit Board Extender for 56-pin circuit board connectors. Its initial use is to provide facility for servicing circuit boards in the Tektronix Type T4002 Graphic Computer Terminal. Test points provide easy access to each of the 56 connections.

067-0616-00

Flexible Extender. Designed for use with 7000-Series instruments to facilitate trouble-shooting and calibration of 7000-Series Plug-In Units on the bench.

The Extender is primarily intended for use with 7000-Series Sampling Plug-Ins but it can also be used with any 7000-Series Plug-In to facilitate trouble-shooting, providing the user recognizes and accepts the possible bandwidth-limiting effects of the extension cable.

067-0620-00

Extender. Designed for use with the 4501 Scan Converter to enable individual circuit cards to be extended for trouble-shooting and calibration operations.

This Short Extender is needed to operationally extend all circuit cards in the 4501, including those which utilize additional flexible cable connections.

The Short Extender Card incorporates coded pin-type test points to allow easy connection of measuring equipment test leads and probes.

067-0621-00

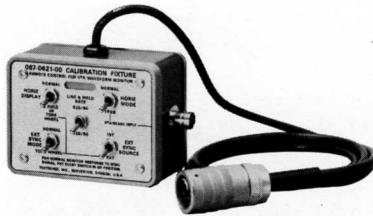

Remote Control Fixture. Designed to provide remote selection of certain operating modes of Type 529 Waveform Monitors that have been modified for Video Tape Recorder (VTR) operation.

067-0622-00

Calibration Shield for 324. Used when adjusting volts/DIV compensations during calibration.

067-0624-00

Probe Shield. A calibration and service aid designed specifically for use with the P6051 FET Probe. The device replaces the P6051 Probe Barrel assembly, allowing convenient access to the probe circuitry for both compensation adjustment and servicing.

067-0625-00



Peak-To-Peak Detector. Designed to measure the output voltage flatness of 50 ohm, constant-amplitude signal generators.

067-0630-00

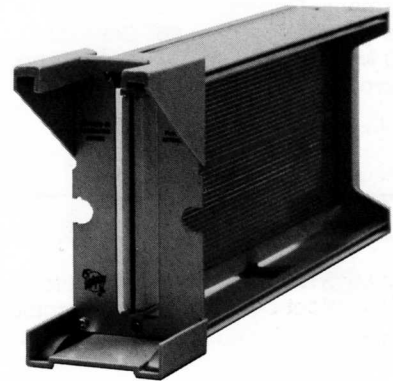

Extender. Used for calibrating or troubleshooting 2600 series Plug-in Units operating in a 2600 Mainframe. The extender allows the 2600 series Plug-in unit to be operated out of the Mainframe compartment, thus providing easy access to components and adjustments.

067-0632-00



Standard Load Resistor. Designed to plug into the 176 Pulsed High-Current Fixture for testing collector and base currents indicated on the 576 Curve Tracer.

FOR TEKTRONIX PRODUCTS

067-0633-00

Interconnecting cables with Amphenol connectors for enabling the 176 Pulsed High-Current Fixture to be operated when removed from the 576 Curve Tracer.

Included in this set of interconnecting cables are two cables 012-0038-01 w/16 contact connectors; one cable 012-0268-00 w/32 contact connectors and one cable 012-0269-00 w/24 contact connectors.

067-0634-00

Circuit Board Extender for 56-pin circuit board connectors. Its initial use is to provide facility for servicing circuit boards in the Tektronix 4901/4902 Interactive Graphic Unit. Test points provide easy access to each of the 56 connections.

067-0635-00

2 ns Filter. Designed to aid in adjusting the 454A Oscilloscope CRT termination and output amplifier high-frequency compensation.

067-0640-00



Calibration Fixture. Used to modulate the sine-wave Marker Output frequencies of the 2901 Time Mark Generator by its Trigger Output signals to produce sidebands and their harmonics. These can then be used to calibrate or check the Frequency Span (MHz/Div) of high frequency Spectrum Analyzers such as the 1401A, 1L20, 491, etc.

067-0645-02

Extender. Used for calibrating or troubleshooting TM500 series Plug-in Units operating in a TM500 Mainframe. The extender allows the TM500 series Plug-in unit to be operated out of the Mainframe compartment, thus providing easy access to components and adjustments.

067-0645-03

Extender. Used for calibrating or troubleshooting 5000-series plug-in units operating in a 5000-series mainframe. The extender allows the 5000-series plug-in unit to be operated out of the mainframe compartment, thus providing easy access to components and adjustments.

067-0648-00

Extender Card. Used with 568.

067-0652-00

Set of Calibration Resistors for 576/172. Used in 172 calibration procedure to check:

- Vertical Display Accuracy
- Current Supply
- Voltage Supply
- Current Limit

067-0653-00

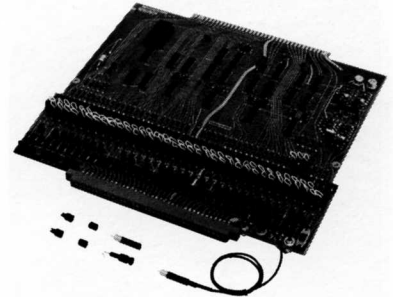

Logic Extender Board. Used as a monitor and test circuit card. Used with circuit cards and minibus connectors such as are used in the Tektronix 4010/4010-1 Computer Display Terminal.

067-0654-00

Display Alignment Graticule for 4010/4051. Used to set x and y gain, position and geometry.

067-0655-00



Signal Pickoff Connector. Used in conjunction with the 067-0616-00 Flexible Extender in order that the 7000 series horizontal or vertical plug-in unit may be operated outside of the oscilloscope and still be properly terminated.

CALIBRATION FIXTURES

067-0657-00



Normalized Ramp Generator. Used to produce a linear sweep ramp useful for calibration of most 7000-series oscilloscope systems. Calibrated sweep rates from 0.5 ns/Div to 50 ns/Div (in a 1-2-5 sequence) plus 1 μ s/Div and 1 ms/Div are provided. The Calibration Fixture is triggered from an external signal (such as a trigger output from a time-mark generator) applied to the front-panel TRIG IN connector.

067-0659-00

Logic Extender Card. Used as a monitor and test circuit card. For use with circuit cards and minibus connectors such as are used in the Tektronix 4020-Series Terminals.

067-0661-00

Manual/Programmable Card Selector (M/P Card). Part of the 1340 Data Coupler Test Set. The M/P Card provides a means of: 1) determining the operating status of the other circuit cards installed in the 1340, and 2) isolating system troubles that relate to the 1340. The test functions of the M/P Card can be performed manually or they can be programmed. Up to 16 test functions can be stored and performed in sequence by operating the M/P Card in its Programmed mode.

067-0662-00

Data Source Board. Part of the 1340 Test Set. This board is used to generate 16 bit data words for testing circuit cards installed in the 1340. The board can be installed in any 1340 circuit card connector except J1.

067-0663-00

Program Data Indicator. Part of the 1340 Test Set. It is used to indicate the logic states of 32 program lines and to set the logic states of two other program lines. The light emitting diodes (LED's) used as logic state indicators are arranged and labeled to correspond with the 16-Bit structure of the circuit cards used in the 1340 Data Coupler. Two 36-pin connectors, J1 and J2, similar to the 36-pin connectors of the 1340, Type 230, and Type 240, are used to loop the program lines through the indicator to permit on-line monitoring.

067-0664-00

Circuit Card Extender Used on 4010. Extends deflection amplifier and storage card.

067-0665-00

BDX Simulator. Designed to drive and monitor the CABUS, the CXBUS, and the associated lines, in the same manner as the BDX 6200 Computer. Additional checkout and troubleshooting capabilities have been added by incorporating a variable clock (VAR CLK) single-step operation, and timing-phase lights.

This simulator makes it possible to exercise the Bendix Interface cards (P1, P2, P3, and P4) in the 1340 Data Coupler as well as the Digitizer and Reference cards and the complete S-3002 system.

067-0667-00

Flexible Extender used on 1501 Chart Recorder.

067-0669-01

Calibration Shield used on 326. Used in calibration procedure to adjust volts/DIV compensations.

067-0671-00

Calibration Graticule used on 613. Used in calibration procedure for:

- Trace Alignment and Geometry
- Amplifier Centering and Size
- Linearity
- Orthogonality

067-0672-00

Vertical Calibration Plug-In used on TLD83. Used to calibrate Mainframe Vertical.

067-0673-00

Horizontal Calibration Plug-In used on TLD83. Used to calibrate Mainframe Horizontal.

067-0675-00

Display Alignment Graticule for 4012/13. Used in calibration to set up display parameters such as geometry, gain and linearity.

FOR TEKTRONIX PRODUCTS

067-0676-00

An insertion unit for use in the Type 475 Oscilloscope. This enables the Calibrator to insert a fast ns signal between the preamplifier and the delay line, making possible the adjustment of the main amplifier before the preamp is adjusted.

067-0680-00

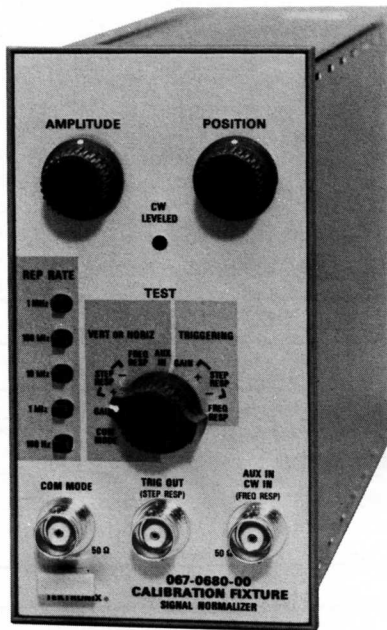

Calibration aid for 5400-series mainframes. The unit is designed to calibrate all 5400-series mainframes for all 5-series plug-in units both vertical and horizontal.

067-0681-01

Tunnel Diode Pulsar. Provides a clean, fast-rise pulse for adjusting the transient response of high frequency oscilloscopes such as the Tektronix Types 475, 485, 7A11, 7A24, and 7A19/7904.

067-0683-00

Extender Card used on P7001. Used for troubleshooting and calibration.

067-0684-00

The 067-0684-00 was made for clean timing signal from 184 time mark generator. The 2 ns output of 184 has 5 ns and 10 ns signals which tend to confuse the operator. The 067-0684-00 filters all but the 2 ns signal. The 067-0684-00 was made for the 184 time mark generator and 475 instrument, but may be used with other time mark generators and other scopes.

067-0687-00

Power Supply Main Board Extender used on 4623, 4631/32/33A/34. Used in calibration and troubleshooting.

067-0688-00

Flexible Plug-In Extender for TLD83. Extends vertical and horizontal plug-ins for troubleshooting.

067-0689-00

Rigid Plug-In Extender for TLD83. Extends plug-ins for calibration.

067-0690-00



High Resolution Test Generator. Provides a variety of signals useful in investigating performance of video processing equipment, such as the Tektronix Hard Copy Units. The generator fits into a Tektronix TM 500-Series Power Module and occupies two compartments.

067-0690-01



High Resolution Test Generator. Provides a variety of signals useful in investigating performance of video processing equipment, such as the Tektronix Hard Copy Units. The generator fits into a Tektronix TM 500-Series Power Module, and occupies two compartments.

067-0691-00

Calibration Resistor Kit used on 577/177-178. Used to set and check voltage and current levels and gains during calibration of the 177, 178.

067-0693-01

Extender Cable used on 5S14/7514. Used to troubleshoot the sampler portion of the 5S14/7S14.

067-0696-00

Extender Card used on 4023. Used as an extender for cards installed in the minibus.

067-0697-00

Calibration Housing used on S-4 and S-6 Sampling Heads.

CALIBRATION FIXTURES

067-0700-00

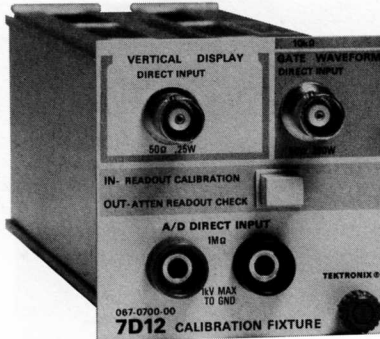

Calibration Plug-In for 7D12.

067-0703-00

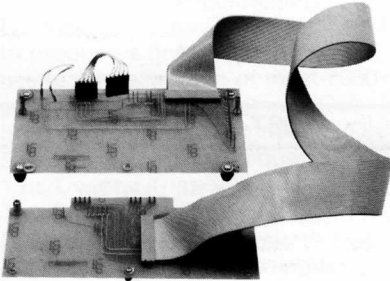

Readout Extender. Used with the Tektronix 5400 Series. The Extender provides facility for troubleshooting or calibration.

067-0704-01

Probe Adapter/Deskew Fixture. An interfacing device that is used to connect an oscilloscope input probe to a test station sector card.

067-0704-02

Calibration Fixture. Provides a means of connecting an oscilloscope probe to the I/O pins of an 1803 D1 or C1 sector card.

067-0705-00

Calibration Resistor Kit used on 577/178. Used in calibration procedure to check/adjust voltage and current levels and gains.

067-0707-00

Extender Board. Included with the R7912 Calibration Kit (067-0713-00). Used to extend any one of the four plug-in cards used in the R7912.

067-0708-00

Circuit Card Extender used on 4623/4631/32/33A/34.

067-0709-00

Interconnecting BNC Cable for R7912. Included with 067-0713-00.

067-0710-00

Calibration Aid. A calibration signal source that is used during several steps in the 7912AD calibration procedure. Also called the Video Calibrator, it provides special-purpose signals used to adjust the 7912AD video preamplifier and processor and to check the horizontal resolution of data acquired by the 7912AD (included with 067-0713-00).

067-0712-00

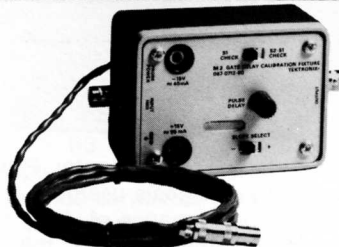

Signal Delay Device. It is intended to provide a signal delay output that is variable from 40 to 600 nanoseconds at a minimum amplitude of 0.5 volt.

067-0713-00

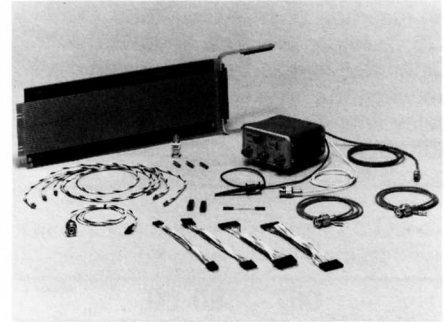

Calibration Kit. Designed to assist in the calibration and repair of the R7912 Transient Digitizer. A card extender, supplied with the kit, may be used to extend any of the R7912 plug-in boards (located behind the R7912 swing-out front panel). Also supplied in the R7912 Calibration Kit is the Calibration Aid. It generates various calibration test signals usable in the R7912 calibration procedure.

067-0721-00

Extender Cable. Used with 577 to permit making adjustments to the test fixture without removing the 577 bottom panel.

067-0742-00

Plug-In Extender Cable used on Sony-Tek 314. Used to extend the storage/time/DIV/ module while making timing and external horizontal adjustments.

067-0743-00

Circuit Card Extender Kit used on 4661. Used for troubleshooting the electronics of the plotter.

FOR TEKTRONIX PRODUCTS

067-0745-00

Sector Card Test Fixture. Used in the test, calibration, and repair of 1803 sector cards. The fixture provides all stimulus required to test and calibrate the functions of a sector card.

067-0746-00

System Test Fixture. A general purpose test device for Tektronix equipment that uses 6800 micro-processors. Several manufacturers make the 6800 processors modeled after a design introduced by Motorola Semiconductor Products, Inc. Due to the sophisticated intelligence offered by these microprocessor devices, Tektronix has developed the System Test Fixture as an aid to troubleshooting these intelligent machines.

067-0747-00

High Voltage Power Supply 10 Conductor Extender Cable for 7704A/7904.

067-0748-00

High Voltage Power Supply 7 Conductor Extender Cable for 7704A/7904.

067-0749-00

Calibration Shield used on Sony-Tek 335. Metal shield with holes corresponding to volts/division compensation adjustments.

067-0750-00

Calibration Shield used on Sony-Tek 314. Used when adjusting volts/DIV compensations.

067-0751-00

Circuit Card Extender Cable Kit for Tek 21/Tek 31. Consists of 067-0751-01 through -06.

067-0751-01

Flexible Extender, 60 Pin. Included with 067-0751-00. Programmer/Calculator board extender.

067-0751-02

Flexible Extender, 30 Pin. Included with 067-0751-00 Printer Extender.

067-0751-03

Flexible Extender, 20 Pin. Included with 067-0751-00 Printer Extender.

067-0751-04

Flexible Extender, 4 Pin. Included with 067-0751-00 Mag Card Reader Extender.

067-0751-05

Flexible Extender, 5 Pin. Included with 067-0751-00 Mag Tape/Printer Power Extender.

067-0751-06

Flexible Extender, 1 Pin. Included with 067-0751-00 Printer Logic Extender.

067-0753-00

Sector I/O Test Ring. Used on 1803.

067-0755-00

Input RC Normalizer 22pF. Used with 7D15.

067-0756-00

Calibration Fixture. Used to verify/adjust the Common Mode Rejection Ratio of the 178 Instrument.

067-0757-00

Module Extender. Used with 455A2/B2.

067-0758-00

Extender used on 213. Used to troubleshoot the A5 Power Board.

067-0759-00

A/D Extender Card used on 213. Used to troubleshoot the A3 A/D Converter Circuit Board.

067-0760-00

Extender used on 221. Used for troubleshooting Power Supply Board.

067-0761-00

Extender used on 221. Used for troubleshooting the Amplifier Board.

067-0764-00

Load and Current Shunt. Used with RECAL III for the adjustment of the 1140A Programmable Power Supply.

CALIBRATION FIXTURES

067-0765-00

Undersocket Test Fixture. Used with S3260. This fixture is capable of checking out all of the pins on the undersocket connector. Its functions are as follows:

- 1140A #2 Voltage Measurement
- 1140A #2 Current Limit
- MC-3 Current Accuracy
- U0-U16 Undersocket Data Bits
- 1803 Fixed Power Supplies
- Initialize
- Station Enable
- DC Channel 1
- DC Channel 2
- Common Bus

With this fixture, recal and verdict programs can completely checkout the undersocket functions.

067-0770-00

1803 A/D Adjustment Card. One of the fixtures specified for S-3260 RECAL III. It is used with the program DCSCAL for the calibration of the A-D converter. Instructions for its use are part of the program DCSCAL.

067-0772-00



Hexadecimal Display Panel. An important programming aid for the 4080-Series Graphic System and is useful in helping to track down circuit problems wherever they may occur in the System. It is normally connected permanently to the Processor, so it can be called into use immediately whenever necessary. The Display Panel is a versatile device, with the ability to enter programs, monitor the execution of programs, and examine and alter the contents of memory. It also offers a built-in counter which is useful for a variety of purposes.

067-0773-00

18" Ribbon Cable with an Interface Connector at each end. Used for troubleshooting T900 Series instruments.

067-0774-00

Extender A/D Digitizer. Used with S3260.

067-0775-00

1802 D2 Probe Adapter/Deskew Fixture. Provides a means of connecting an oscilloscope probe to the I/O pins of an 1803 D2 sector card.

067-0776-00

Resistor Set. Used when the MC-1 Option is part of the S-3260 Automated Measurement System to establish current values for the calibration of the MC-1 current ranges.

The resistor set consists of two resistor assemblies: 325-0197-01 contains a 100 M/ohm resistor and a 325-0198-01 contains a 10 G/ohm resistor. The 1% tolerance, 0.5 Watt resistors are encased in an electro-magnet shield as shown in the exploded view.

Directions for using the resistor set are part of the S-3260 RECAL procedure.

067-0777-00

Delta-T RECAL Fixture. Provides accurate timing signals for the adjustment of the 1803 Delta-T Subsystem. It plugs into the 1803 undersocket connector to obtain power and control bits. Start, stop, and program cycle timing signals from the Delta-T Subsystem are derived by the fixture from the 1803 data-phase signal.

067-0778-00

RECAL III Calibrations Programs, S3260.

067-0781-01

Calibration Software Tape. 4051 Head Alignment Tape. P/O 003-0782-00. 4051 Field Service Kit.

FOR TEKTRONIX PRODUCTS

067-0788-00

Head Alignment Fixture. Ensures that the tape head on digital tape units is correctly positioned with respect to other mechanical parts on the unit. Use the fixture after head replacement or mechanical disassembly, or when tape head position causes data errors. If the position of the tape head is changed during use of the fixture, the tape head's height and skew adjustments should be checked using the adjustment procedure described in the unit's service manual. The Head Alignment Fixture is used on the following units:

- 4923 Digital Cartridge Tape Recorder
- 4924 Digital Cartridge Tape Recorder
- 4051 Graphic System
- 4081 Graphic System

067-0790-00

Mag Tape/GPIB Test Board for 4051. Mag Tape IEC Test Fixture. P/O 003-0782-00. 4051 Field Service Kit.

067-0792-00

Alignment Tape used on Tek 31.

067-0794-00

Romulan Loader Card. A special purpose circuit card that plugs into the card cabinet of the 4081 Graphic System; it loads programs or data into the 4081 System's Memory. Romulan is equipped with four sockets for mounting Programmable Read-Only Memory (PROM) devices which permanently store the program to be loaded.

067-0795-00

Custom Extender. Used with circuit cards in a 4081 Graphic System to allow a service technician access to test points on operating circuit cards.

067-0799-00

Calibration Fixture Unique to IDP Custom Modified Instruments. IBM System 7 parallel interface.

067-0801-00

4014/4015 Monitor Adapter Cable used on 619.

067-0804-00

Interface Calibration Fixture. Serves as a buffer between the System Test Fixture (067-0746-00) and the DF1.

067-0805-00

Cable Extender. Allows the DF1 to operate remote from the 7D01 plug-in unit.

067-0807-00



DVST Display Exerciser. Used to remotely control and test the performance characteristics of the GMA-Series Display Monitors. The Exerciser generates 14 different test patterns for checking or calibrating such things as deflection amplifier response in the long or short axis, beam focus and intensity, vector linearity, image resolution and luminance, etc.

067-0811-00

Buffer Adapter Test Board. Used with 4924.

067-0813-00

Extender Card used on 4663. Used to gain access to voltage points during calibration.

067-0815-00

E H Generator Calibration Fixture, S-3200.

067-0816-00

Sector Card Load Board, D1B.

067-0817-00

Flexible Extender. Used with the GMA series Storage Display Modules. It is a troubleshooting aid for the Storage, Deflection, and Character/Vector Generator boards. It can also be used to test circuits designed using the optional Vector board kit.

067-0818-00

Graticule Calibration Fixture, GMA 101A, GMA102A.

CALIBRATION FIXTURES

067-0819-00

Extender Board for troubleshooting, SC502, SC503, and SC504.

067-0823-01

Parcal, Parts Fixture, S3455. Parametric calibration fixture—test head socket card containing precision resistors connected from various pins to ground and used for calibrating and diagnosing the S-3455 parametrics unit.

067-0824-00

Calibration Fixture for 4924 Test PROM.

067-0825-00

1847/1848 Verification Socket Board. 1848 Verification Card. A S-3455 socket card with 54 precision resistors inserted between the test head pins and a common; used to verify correct operation of 1848 test head.

067-0827-00

Deskew Socket Card. Contains 60 test scope socket connectors (P/O 020-0290-00 RECAL Kit).

067-0828-01

Card Extender. Used in troubleshooting 8002.

067-0829-00

Used with 067-0831-00 Diagnostics Test Fixture. Test tape used to verify and test 4662 digital plotter operation. Consists of:

- Cartridge Test Tape
- GPIB (IEC) Overlay
- RS-232 Overlay
- 4662 Test Graticule
- 4662 Test Tape Operator's Manual

067-0831-00

Diagnostic Test Fixture. Used with 4662.

067-0832-01

T.I.M.E. Delay Standard, S3200.

067-0836-01

Comparator Threshold Fixture, S3455. Buffer RAM diagnostics fixture. A S-3455 test head socket with the Y address pins hardwired to the data pins; used to check buffer RAM and comparators.

067-0839-00

Hardware Trace Upper Address Data Test Fixture. Used with 8001/8002. Included with 067-0841-00.

067-0841-00

Hardware Test Package. 8001/8002. Contains System Hardware test manual, the 8001/8002 Diagnostic Disc, and the Hardware Trace Address Data Test Fixture.

067-0842-00

8001/8002 Maintenance Front Panel. Provides system control and diagnostic functions including system restart, program breakpoint control, program singlestepping, diagnostic interrupt, forced program jump, and control over which CPU is active.

067-0843-00

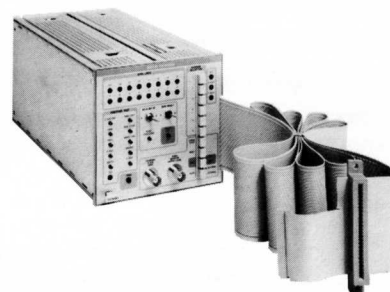

Digital Exerciser. Used to remotely control and test Option 32 in the GMA 101A Display Monitor and Options 42 or 43 GMA102A Display Monitor. These options are:

- Option 32 Character/vector generator
- Option 42 High speed vector generator
- Option 43 High speed vector/dot character generator (used only with Option 42)

067-0845-00

Dot Generator. Used for adjusting the focus, uniformity, and geometry of cathode-ray tubes (crt) in display devices such as the Tektronix 600-series Monitors.

067-0846-00

Extender Card used on 4025. Used to extend boards for troubleshooting.

FOR TEKTRONIX PRODUCTS

067-0850-00

Calibration Program used on 4081 and 4905. Used to adjust the circuitry.

067-0851-00

Interconnecting Cable, Calibration Fixture, 400 Recorder Aid.

067-0854-00

7912AD Calibration Kit. Provides signals and makes signal connections for calibration and repair of the Tektronix 7912AD Programmable Digitizer. For these purposes, the kit contains a calibration signal source, cables, and extender cards. The calibration signal source is the same one supplied with the R7912 Calibration Kit (067-0713-00); however, new cables and extenders have been substituted as necessary.

067-0856-00

Plugs into the system test fixture (067-0746-00) and contains programs for testing the 4907.

067-0859-00

Circuit Board that plugs into 4663. Contains firmware that runs the processor for diagnosing.

067-0860-01

Comparator Socket Card used on S3455 (P/O 020-0290-00 RECAL Kit).

067-0862-00

Extender Cable used on 608.

067-0865-00

The 067-0865-00 provides a convenient means of obtaining a clean square wave from a 50 ohm system for use during calibration and repair of the P6303/AM503.

067-0867-00

Calibration Shield used on 442. Used during calibration of vertical circuits. The shield simulates the case capacitance to ensure proper calibration.

067-0868-00

Phase Lock Module Extender used on 7L18. Part of Kit 006-2487-00.

067-0869-00

Standard Module Extender used on 7L18 (P/O 006-2487-00).

067-0870-00

Narrow Module Extender used on 7L18 (P/O 006-2487-00).

067-0875-00

Calibration Fixture. Provides a convenient, accurate means to check and/or adjust any 50 ohm load. It is commonly used in the calibration procedures of Tektronix instruments such as the 485, 7A19, 7A24 and 7A29 to check or adjust the low frequency input impedance to 50 ohms.

067-0877-00

Calibration Graticule. Used in calibrating the GMA 125 Storage Monitor. The calibration technician installs the graticule over the screen of the monitor and applies a cross-hatch pattern from the 067-0807-00 DVST Display Exerciser to the monitor. He then adjusts the monitor Gain and Position circuitry to get a conformance of the cross-hatch pattern to the lines on the graticule.

067-0878-00

Self Test Adapter. An optional test fixture used to calibrate and troubleshoot the 832 Data Comm Tester. It also is required to perform one of the self test routines of the 832, and is a convenience for some of the other self test routines.

067-0879-00

Extender Board and Cable used on 634.

067-0882-00

Extender Card used on 4027. Used to extend the display while adjusting convergence.

067-0884-00

Calibration Graticule used on 4027.

067-0885-00

Microwave Comb Generator recommended for calibration of the 7L18 Spectrum Analyzer.

CALIBRATION FIXTURES

067-0892-00

Microcomputer System Tester used on 8002.

Microlab I MDL
7854
Programmable TM 500

Test fixture for microprocessor controlled equipment. Mainframe that can accept "Personality Cards" to adapt to any microprocessor.

067-0896-00

Diode Switching Matrix, S-3455.

067-0899-00

Extender Cabler. Used with the Television Down Converter Plug-in Unit to the 1450-1 Television Demodulator. Provides for servicing the Down Converter outside of the 1450-1 Mainframe.

067-0900-00

Diagnostic ROM Pack used on 4052/54. Used to isolate problems to circuit board level plus running ROM and RAM checks. Also used to exercise the system after repair and provide calibration data for display and tape units.

067-0901-00

This tape contains BASIC programs that verify the proper operation of 4050 Series Graphic Computing Systems. The programs support various configurations of peripherals connected to a Graphic Computing System. The peripherals include:

- 4907 File Manager
- 4924 Digital Cartridge Tape Drive
- 4956 Graphics Tablet
- 4662 Interactive Digital Plotter

The verification and Service Tape also checks floating point calculations and data communications (provided by Options 1 and 3, Data Communications Interfaces). Test patterns generated by the tape aid in calibration of the Graphic Computing System's display circuitry. Programs on the Verification and Service Tape require the Graphic Computing System to be equipped with 16K bytes of memory.

To use the Verification and Service Tape, insert it into a 4050 Series Graphic Computing System. Turn the power switch on, and press the AUTOLOAD key. The program then displays a selection menu. From this point on follow the directions displayed on the screen.

067-0904-00

Sector Card Probe Adaptor, 1805.

067-0910-00

Extender Board. Used with 067-0892-00. Extends "Personality" Card for access.

067-0938-00

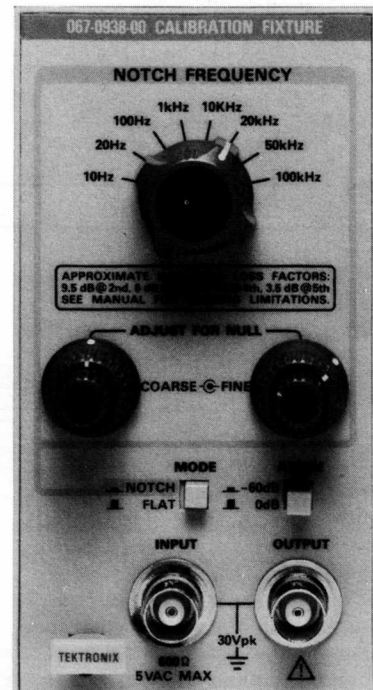

Notch Filter Calibration Fixture. A passive notch filter designed for calibration of the SG 505 Oscillator.

067-0948-00

Test Graticule. Used with 4054.

067-0958-00

Service Extender Kit. Used with 606B.

067-0962-00

Service ROM Pack. A diagnostic ROM pack for the 4051 Graphic System. It contains diagnostic routines for testing both Read Only (ROM) and Read/Write Random Access Memory. Routines are also included for recovering damaged tape files, cycling tapes, and displaying patterns for adjustment purposes.

FOR TEKTRONIX PRODUCTS

067-5001-00

CCIR System A 405/50 Line/Field Rate Plug-In Unit. Provides control of the line and field rate, sync timing, and sync pulse counting for the Tektronix 067-0601-00 Television Test Signal Generator. The plug-in unit with its generator provides a source of composite television signals for calibration and adjustment of television waveform monitors and other equipment.

067-5005-00

CCIR System F 819/50 Line/Field Rate Plug-In Unit. Provides control of the line and field rate, sync timing, and sync pulse counting for the Tektronix 067-0601-00 Television Test Signal Generator. The plug-in unit with its generator provides a source of composite television signals for calibration and adjustment of television waveform monitors and other equipment.

067-5009-00

EIA Standard 1029/60 Line/Field Rate Plug-In Unit. Provides control of the line and field rate, sync timing, and sync pulse counting for the Tektronix 067-0601-00 Television Test Signal Generator. The plug-in unit with its generator provides a source of composite television signals for calibration and adjustment of television waveform monitors and other equipment.

067-5002-00

CCIR System M 525/60 Line/Field Rate Plug-In Unit. Provides control of the line and field rate, sync timing, and sync pulse counting for the Tektronix 067-0601-00 Television Test Signal Generator. The plug-in unit with its generator provides a source of composite television signals for calibration and adjustment of television waveform monitors and other equipment.

067-5006-00

EIA Standard 729/60 Line/Field Rate Plug-In Unit. Provides control of the line and field rate, sync timing, and sync pulse counting for the Tektronix 067-0601-00 Television Test Signal Generator. The plug-in unit with its generator provides a source of composite television signals for calibration and adjustment of television waveform monitors and other equipment.

067-5010-00

EIA Standard 1201/60 Line/Field Rate Plug-In Unit. Provides control of the line and field rate, sync timing, and sync pulse counting for the Tektronix 067-0601-00 Television Test Signal Generator. The plug-in unit with its generator provides a source of composite television signals for calibration and adjustment of television waveform monitors and other equipment.

067-5003-00

CCIR System B 625/50 Line/Field Rate Plug-In Unit. Provides control of the line and field rate, sync timing, and sync pulse counting for the Tektronix 067-0601-00 Television Test Signal Generator. The plug-in unit with its generator provides a source of composite television signals for calibration and adjustment of television waveform monitors and other equipment.

067-5007-00

EIA Standard 875/60 Line/Field Rate Plug-In Unit. Provides control of the line and field rate, sync timing, and sync pulse counting for the Tektronix 067-0601-00 Television Test Signal Generator. The plug-in unit with its generator provides a source of composite television signals for calibration and adjustment of television waveform monitors and other equipment.

067-5011-00

Adapter Cable for 606. Used with 067-0561-01, DOT Generator.

067-5004-00

CCIR System E 819/50 Line/Field Rate Plug-In Unit. Provides control of the line and field rate, sync timing, and sync pulse counting for the Tektronix 067-0601-00 Television Test Signal Generator. The plug-in unit with its generator provides a source of composite television signals for calibration and adjustment of television waveform monitors and other equipment.

067-5008-00

EIA Standard 945/60 Line/Field Rate Plug-In Unit. Provides control of the line and field rate, sync timing, and sync pulse counting for the Tektronix 067-0601-00 Television Test Signal Generator. The plug-in unit with its generator provides a source of composite television signals for calibration and adjustment of television waveform monitors and other equipment.

ASIA, AUSTRALIA, CENTRAL & SOUTH AMERICA, JAPAN

ARGENTINA
Coasin S.A.
Buenos Aires
Phone: 52-3185, 51-9363

AUSTRALIA
Tektronix Australia Pty. Limited
Sydney
Phone: 888-7066

Adelaide
Phone: 223-2811

Melbourne
Phone: 818-0594

Perth
Phone: 325-4198

Brisbane, Queensland
Phone: 394-1560

Canberra
Australian (Capital) Territories
Phone: 52-5587

BOLIVIA
Coasin Bolivia S.R.L.
La Paz
Phone: 40962

BRAZIL
Tektronix Industria e Comercio Ltda.
Sao Paulo
Phone: 813-3011

Rio de Janeiro
Phone: 266-5364, 286-6946

CHILE
Equipos Industriales S.A.C.I.
Santiago
Phone: 716-882, 382-942

CHINA, PEOPLES REPUBLIC OF
Tektronix Export Marketing
USA
Phone: (503) 844-0161

COLOMBIA
Selectronica Ltda.
Bogota
Phone: 632874, 422376

COSTA RICA
Electro-Implex, S.A.
San Jose
Phone: 21-59-54

ECUADOR
Proteco Coasin Cia Ltda.
Quito
Phone: 52-6759, 52-9684

EL SALVADOR
Electronica Cuscatleca, S.A. de C.V.
San Salvador
Phone: 22-0297

HONG KONG
Gilman & Co. Ltd.
Electrical/Electronic Dept.
Causeway Bay
Phone: 5-794266

INDIA
Hinditron Services Private Ltd.
Bombay
Phone 81 13 16/81 53 44

Bangalore
Phone: 33139

INDONESIA
P.T. Dwi Tunggal Jaya Sakti
Jakarta
Phone: 367390-9, 356801-5, 356801-5

JAPAN
Sony/Tektronix Corporation
Tokyo
Phone: 448-4611 (Area 03/Tokyo)

Tokyo
Phone: 710-8141 (Area 03/Tokyo)

Osaka-shi
Phone: 312-2751 (Area 06/Osaka)

Nagoya
Phone: 581-3548 (Area 052/Nagoya)

KOREA
M-C International (Korea) Ltd.
Seoul
Phone: (56) 6131 thru 6138

MALAYSIA
Mecomb Malaysia Sdn. Bhd.
Petaling Jaya, Selangor
Phone: 773455

MEXICO
Tecnicos Argostal, S.A.
Mexico City
Phone: 515-85-80

Monterrey, N.L.
Phone: 51-13-60

Guadalajara, Jal.
Phone: 1725-46, 17-78-12

NEW ZEALAND
W. & K. McLean Ltd.
Auckland
Phone: 587-037

Wellington
Phone: 851-450

PAKISTAN
Pak-Land Corporation
Karachi
Phone: 437315, 438084

PANAMA
Executive Marketing Corp.
Panama
Phone: 64-9354, 64-9851

PERU
Importaciones y Representaciones Electronicas S.A. (IRE Ingenieros)
Lima
Phone: 28-86-50

PHILIPPINES
Philippine Electronic Industries, Inc.
Makati, Rizal
Phone: 87-99-26, 87-99-27, 87-99-28

SINGAPORE
Mechanical & Combustion Engineering Co. Pte. Ltd.
Singapore
Phone: 647151

SRI LANKA
Maurice Roche Limited
Colombo
Phone: 25846, 25847, 25848

SURINAM
Wong Sang Tsoi & Co.
Paramaribo
Phone: 73511, 75187, 72154, 76369

TAIWAN
Heihten Trading Co. Ltd.
Taipei
Phone: 551-916

THAILAND
G. Simon Radio Company Ltd.
Bangkok
Phone: 30991-3

URUGUAY
Coasin Uruguay S.R.L.
Montevideo
Phone: 91-79-78

VENEZUELA
Equilab, C.A.
Caracas
Phone: 283.1166 (5 lines)

Areas Not Listed, Contact:
Tektronix, Inc.
Beaverton, Oregon
Phone: (503) 644-0161

CANADA

CANADA
Tektronix Canada Ltd.
Barrie, Ontario
Phone: (705) 737-2700

(Montreal)
Pointe Claire, Quebec
Phone: (514) 897-5340

Calgary, Alberta
Phone: (403) 269-3138

Edmonton, Alberta
Phone: (403) 434-9466

Ottawa, Ontario
Phone: (613) 225-2850

(Vancouver)
Burnaby, B.C.
Phone: (604) 438-4321

Winnipeg, Manitoba
Phone: (204) 632-4447, 632-4448

(Halifax)
Dartmouth, Nova Scotia
Phone: (902) 469-9476

Canadian Areas Not Listed, Contact:
Tektronix Canada Limited
Barrie, Ontario
Phone: (705) 737-2700

AFRICA, EUROPE, MIDDLE EAST

ALGERIA
Measurelec
Algiers
Phone: 61.50.99 and 61.50.24 (Algiers)

ANGOLA
Tecnidata
Representacoes Tecnicas e Electronica Aplicada Ltda.
Luanda
Phone: 32025-32309

AUSTRIA
Rohde & Schwarz-Tektronix Ges.m.b.H.
Vienna
Phone: Vienna 62 61 41

BELGIUM
Tektronix nv/sa
Bruxelles
Phone: 02/720.80.20

BULGARIA
Rohde & Schwarz-Tektronix Ges.m.b.H.
Vienna, Austria
Phone: Vienna 62 61 41

CZECHOSLOVAKIA
Rohde & Schwarz-Tektronix Ges.m.b.H.
Vienna, Austria
Phone: Vienna 62 61 41

DENMARK
Tektronix A/S
Hertof
Phone: (02) 84 56 22

EAST AFRICA (Kenya, Tanzania and Uganda)
Engineering & Sales Co., Ltd.
Nairobi, Kenya
Phone: 26815

EGYPT
Giza Systems Engineering Company
Cairo
Phone: 841200, 849399, 849200

FEDERAL REPUBLIC OF GERMANY
Rohde & Schwarz Handels Ges.m.b.H.
Berlin
Phone: (030) 3 41 40 36

Rohde & Schwarz Vertriebs Ges.m.b.H.
Hamburg
Phone: (340) 38 01 91

Karlsruhe
Phone: (0721) 2 79 81

Koln
Phone: (0221) 77 22-1

Munchen
Phone: (089) 41 62-1

Numberg
Phone: (0911) 6 48 81

Stuttgart
Phone: (0711) 72 20 39

FINLAND
Tektronix O/Y
Helsinki
Phone: 90-722 400

FRANCE
TEKTRONIX Orsay
Phone: 907 78 27

Lyon
Phone: (78) 76.40.03

Aix-en-Provence
Phone: (42) 59 24 66

Rennes
Phone: (99) 51 21 16

Strasbourg
Phone: (88) 39 49 35

Toulouse
Phone: (61) 40 24 50

GREECE
Marios Dalleggio Representations
Athens
Phone: 710.669

HUNGARY
Rohde & Schwarz-Tektronix Ges.m.b.H.
Vienna, Austria
Phone: Vienna 62 61 41

ICELAND
Kristjan O. Skagfjord Ltd.
Reykjavik
Phone: 24120

IRAN
Irantronics Company Ltd.
Tehran
Phone: 828294, 831564, 836466, 834459

IRAQ
Al Manar Engineering WLL
Baghdad
Phone: 60992 or 8880333

ISRAEL
Eastronics Ltd.
Tel Aviv
Phone: 475151

ITALY
Tektronix S.p.A.
Milano
Phone: 8466440/8466446

Roma
Phone: 481111

Torino
Phone: 330143/372163

IVORY COAST
SITEL
Abidjan 01
Phone: 353600 or 353502

JORDAN
TAREQ Scientific Bureau
Amman
Phone: 42333

KUWAIT
TAREQ Company
Phone: 436100 & 436045

LEBANON
Projects S.A.L.
Beirut
Phone: 331680

MOROCCO
SCRIM
Casablanca
Phone: 27 69 11

THE NETHERLANDS
Tektronix Holland N.V.
Badhoevedorp
Phone: 02968-1456

NORWAY
Tektronix Norge A/S
Oslo
Phone: 02-212855

POLAND
Rohde & Schwarz-Tektronix Ges.m.b.H.
Vienna, Austria
Phone: Vienna 62 61 41

PORTUGAL
Equipamentos de Laboratorio Lda.
Lisbon
Phone: 97 65 51

REPUBLIC OF SOUTH AFRICA
Protea Physical & Nuclear Instrumentation (Pty.) Ltd.
Transvaal
Phone: (27 11) 786-3647

Paardenland (Cape Town Branch)
Phone: 51-3247

Durban
Phone: 39-1100

ROMANIA
Rohde & Schwarz-Tektronix Ges.m.b.H.
Vienna, Austria
Phone: Vienna 62 61 41

SAUDI ARABIA
Electronic Equipment Marketing Co. Ltd.
Riyadh
Phone: 32700, 37023

SPAIN
Tektronix Espanola S.A.
Barcelona
Phone: 228-0716

Madrid
Phone: 734-83-16

SUDAN
Cine & Photo Supply Company (CPSO)
Khartoum
Phone: 75162, 76943 and 42478

SWEDEN
Tektronix AB
Solna
Phone: 0883 00 80

Gothenburg
Phone: 031742 70 35

SWITZERLAND
Tektronix International A.G.
Zug
Phone: 042 21 91.92

SYRIA
General Trading Company
Damascus
Phone: 114807, 224170, 559108

TURKEY
Erkman Elektronik Aletler
Istanbul
Phone: 44 15 46/44 76 51

TUNISIA
EL ESLEK
Tunis
Phone: 244372

UNITED KINGDOM
Tektronix U.K. Limited
Harpden
Phone: Harpenden 63141, 61251

Manchester
Phone: 061-224-0446

Livingston
Phone: Livingston 32766

USSR
Rohde & Schwarz-Tektronix Ges.m.b.H.
Vienna, Austria
Phone: Vienna 62 61 41

YUGOSLAVIA
Rohde & Schwarz-Tektronix Ges.m.b.H.
Vienna, Austria
Phone: Vienna 62 61 41

ZAMBIA
Baird and Tatlock (Zambia) Ltd.
Lusaka
Phone: 753156

Noia
Phone: 3522 & 2253/4/6

Eastern European Countries Not Listed, Contact:
Rohde & Schwarz-Tektronix Ges.m.b.H.
Vienna, Austria
Phone: Vienna 62 61 41

Other Area Not Listed, Contact:
Tektronix Limited
Guernsey, Channel Islands
Phone: Guernsey 35781

UNITED STATES

U.S.A.
Tektronix, Inc.
Beaverton, Oregon
Phone: (503) 644-0161

FIELD OFFICES
ALABAMA
Huntsville
Phone: (205) 881-2912

ARIZONA
Phoenix
Phone: (602) 268-8861

CALIFORNIA
(Concord)
Pleasant Hills
Phone: (415) 932-4949
(415) 932-4722
From Oakland: (415) 254-5353

Irvine
Phone: (714) 556-8080-89
(213) 778-5225, 26

(Los Angeles)
Woodland Hills
Phone: (213) 999-1711

San Diego
Phone: (714) 292-7330

Santa Clara
Phone: (408) 496-0800

COLORADO
(Denver)
Englewood
Phone: (303) 773-1011

CONNECTICUT
Milford
Phone: (203) 877-1494

FLORIDA
Fort Lauderdale
Phone: (305) 731-1220
Also serves Puerto Rico and U.S. Virgin Islands
From Miami: 947-6053

Orlando
Phone: (305) 894-3911
From the Cape Kennedy Area: 838-0343

Pensacola
Phone: (904) 476-1897

GEORGIA
(Atlanta)
Norcross
Phone: (404) 449-4770

HAWAII
Honolulu Service Center
EMC Corporation
Phone: (808) 847-1138

ILLINOIS
(Chicago)
Rolling Meadows
Phone: (312) 259-7580

INDIANA
Indianapolis
Phone: (317) 545-2351

KANSAS
(Kansas City)
Overland Park
Phone: (913) 341-3344

LOUISIANA
(New Orleans)
Kenner
Phone: (504) 466-4445

MARYLAND
(Baltimore)
Lutherville
Phone: (301) 321-7000

Rockville
Phone: (301) 948-7151

MASSACHUSETTS
(Boston)
Lexington
Phone: (617) 861-6800

MICHIGAN
(Detroit)
Farmington
Phone: (313) 478-5200

MINNESOTA
St. Paul
Phone: (612) 484-8571

MISSOURI
(St. Louis)
Hazelwood
Phone: (314) 731-4696

NEW JERSEY
Woodbridge
Phone: (201) 636-8616

NEW MEXICO
Albuquerque
Phone: (505) 265-5541

NEW YORK
(Albany)
Albany
Phone: (518) 458-7291

(Long Island)
Woodbury, L.I.
Phone: (516) 364-9060
(212) 895-9215

Poughkeepsie
Phone: (914) 454-7540

Rochester
Phone: (716) 244-2600

(Syracuse)
North Syracuse
Phone: (315) 455-6661
From New York: (800) 962-1095

NORTH CAROLINA
Raleigh
Phone: (919) 782-5624

OHIO
(Cleveland)
Middleburg Heights
Phone: (216) 243-8500

Dayton
Phone: (513) 859-3681

OKLAHOMA
Oklahoma City
Phone: (405) 848-3361

OREGON
(Portland)
Tigard
Phone: (503) 620-9100

Factory Service Center
Tektronix Industrial Park
Beaverton
Phone: (503) 644-0161

PENNSYLVANIA
(Philadelphia)
Sue Bell
Phone: (215) 825-6400

Pittsburgh
Phone: (412) 244-9800

TENNESSEE
Knoxville
Phone: (615) 690-6422

TEXAS
Dallas
Phone: (214) 233-7791

Houston
Phone: (713) 933-3000

San Antonio
Phone: (512) 434-4334

UTAH
Salt Lake City
Phone: (801) 486-1091

VIRGINIA
Hampton
Phone: (804) 874-0099

WASHINGTON
Kent
Phone: (206) 575-0180

TEKTRONIX WORLDWIDE MARKETING CENTERS

U.S.A.
Tektronix, Inc.
U.S. Marketing
Beaverton, Oregon
Phone: (503) 644-0161

AFRICA, EUROPE, MIDDLE EAST
Tektronix International Inc.
European Marketing Centre
Amstelveen, The Netherlands

AMERICAS/PACIFIC
(Asia, Australia, Central & South America, Japan)
Tektronix, Inc.
Export Marketing
Beaverton, Oregon
Phone: (503) 644-0161

1/80

TEKTRONIX, INC.
CALIBRATION FIXTURES CATALOG
REQUEST/COMMENT FORM

Phone () _____ Ext. _____

Name _____ Title/Position _____

Symbol/Code _____

Address _____

City _____ State _____ Zip _____

- Please send me _____ additional copy(ies) of the Tektronix Calibration Fixtures Catalog in micro-fiche/printed form. (circle one)
- Please send me one set of the microfiche Parts Price List (Replacement Parts).
- Please contact me regarding _____
- I would like additional information on _____
- Please send me your latest general catalog.
- Please add me to your mail list so I will receive revised copies of the Tektronix Calibration Fixtures Catalog. I prefer microfiche/printed form. (circle one)

Comments/Recommendations/Additions _____

TEKTRONIX, INC.
CALIBRATION FIXTURES CATALOG
REQUEST/COMMENT FORM

Phone () _____ Ext. _____

Name _____ Title/Position _____

Symbol/Code _____

Address _____

City _____ State _____ Zip _____

- Please send me _____ additional copy(ies) of the Tektronix Calibration Fixtures Catalog in micro-fiche/printed form. (circle one)
- Please send me one set of the microfiche Parts Price List (Replacement Parts).
- Please contact me regarding _____
- I would like additional information on _____
- Please send me your latest general catalog.
- Please add me to your mail list so I will receive revised copies of the Tektronix Calibration Fixtures Catalog. I prefer microfiche/printed form. (circle one)

Comments/Recommendations/Additions _____

